

PHS 28B-1A76

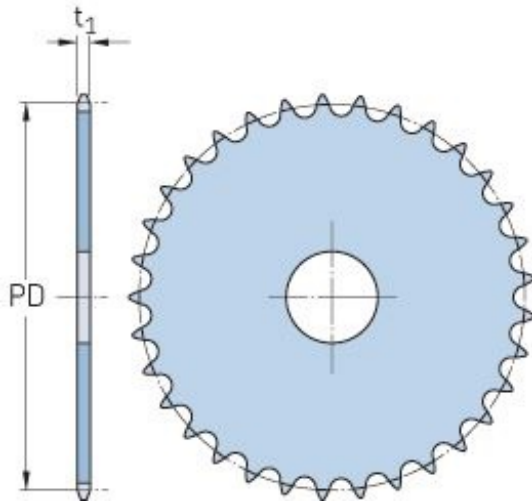

Pitch P (mm)	44.45
Pitch P (in)	1.75
No. of teeth	76
Pitch diameter (mm)	1075.62
Pitch diameter (in)	42.35
Min. bore (mm)	-
Min. bore (in)	-
Max. bore (mm)	-
Max. bore (in)	-
Hub H (mm)	-
Hub H (in)	-
Hub L (mm)	-
Hub L (in)	-
Weight (kg)	147.6
Weight (lbs)	325.4