

PHS 24B-1A40

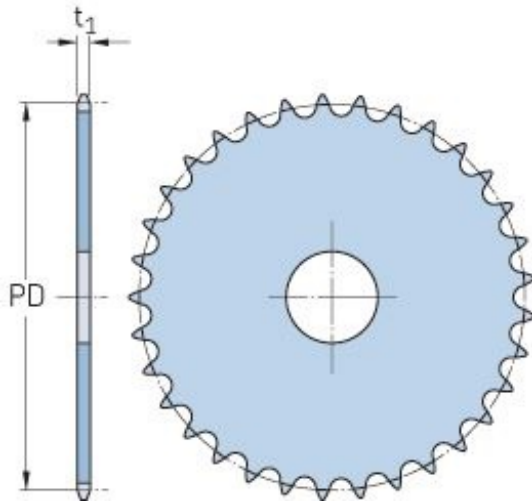

Pitch P (mm)	38.1
Pitch P (in)	1.5
No. of teeth	40
Pitch diameter (mm)	485.6
Pitch diameter (in)	19.12
Min. bore (mm)	-
Min. bore (in)	-
Max. bore (mm)	-
Max. bore (in)	-
Hub H (mm)	-
Hub H (in)	-
Hub L (mm)	-
Hub L (in)	-
Weight (kg)	36.23
Weight (lbs)	79.87