

PHS 24B-1A28

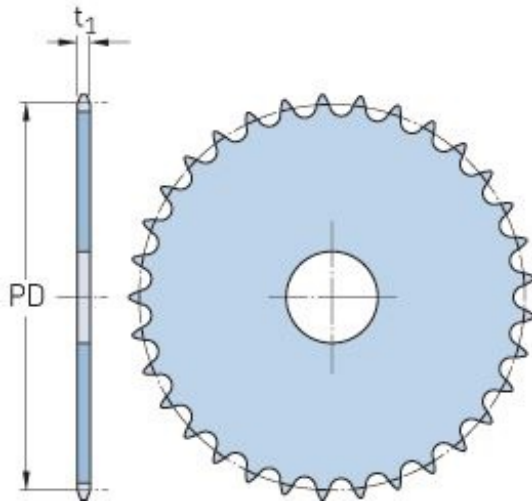

Pitch P (mm)	38.1
Pitch P (in)	1.5
No. of teeth	28
Pitch diameter (mm)	340.29
Pitch diameter (in)	13.4
Min. bore (mm)	-
Min. bore (in)	-
Max. bore (mm)	-
Max. bore (in)	-
Hub H (mm)	-
Hub H (in)	-
Hub L (mm)	-
Hub L (in)	-
Weight (kg)	15.89
Weight (lbs)	35.03