

PHS 12B-1A31

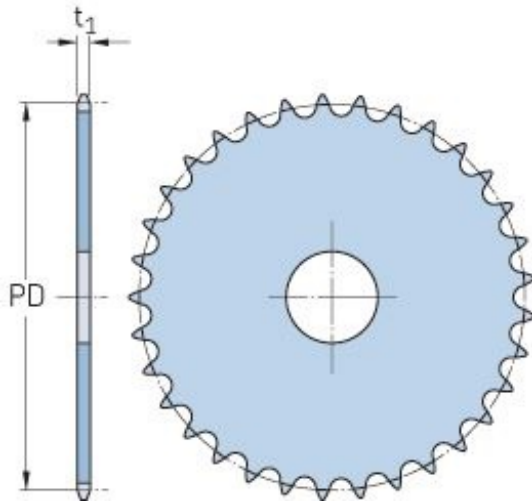

Pitch P (mm)	19.05
Pitch P (in)	0.75
No. of teeth	31
Pitch diameter (mm)	188.31
Pitch diameter (in)	7.41
Min. bore (mm)	-
Min. bore (in)	-
Max. bore (mm)	-
Max. bore (in)	-
Hub H (mm)	-
Hub H (in)	-
Hub L (mm)	-
Hub L (in)	-
Weight (kg)	2.26
Weight (lbs)	4.98