

# PHS 120-1A22

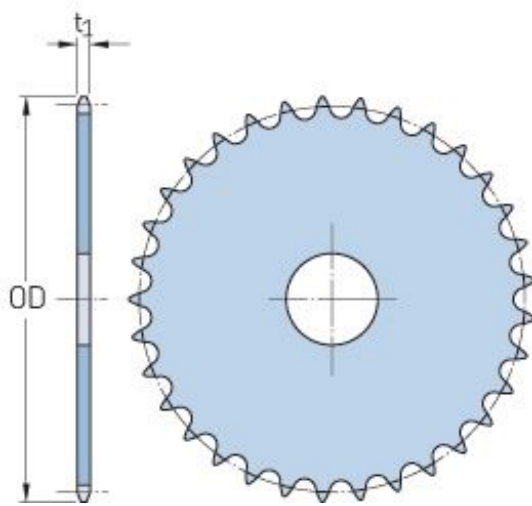

Pitch P (in)	1.5
No. of teeth	22
Diameter (in)	11.33
Min. bore (in)	-
Max. bore (in)	-
Hub H (in)	-
Hub L (in)	-
Weight (lbs)	20