

PHS 50-1A84

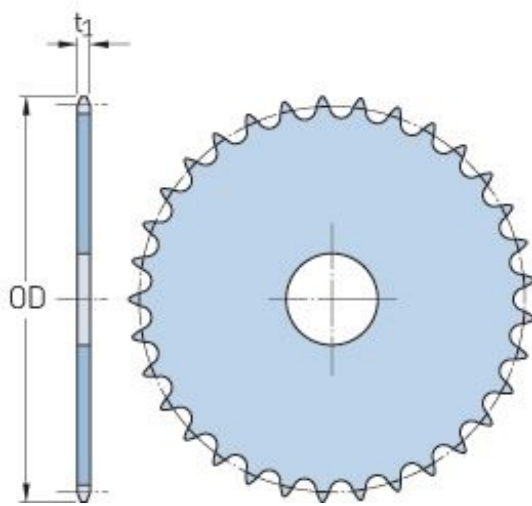

Pitch P (in)	0.63
No. of teeth	84
Diameter (in)	17.08
Min. bore (in)	-
Max. bore (in)	-
Hub H (in)	-
Hub L (in)	-
Weight (lbs)	22.08